

# PNEUMATIC DIGITAL LINEAR GAUGES



DUSTPROOF  
WATERPROOF

ABSOLUTE ENCODER, THE ORIGINAL  
DATA REMAINS AFTER POWER OFF



**7134-10L-U**

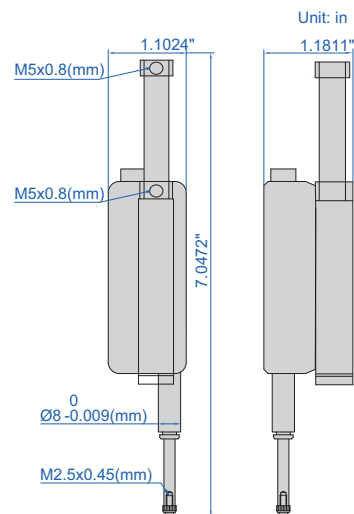

- Scale type: optical grating
- Absolute encoder, the original data remains after power off
- Digital signal output, amplifier is not required
- Air pressure: 0.2-0.5MPa
- Measuring force: ≤1.5N
- Dust/waterproof: IP43/IP66
- Baud rate: 9600 (can be customized)
- Cable length: 9.84Ft (can be customized)



## Dust/waterproof IP43, resolution 10µin

Code	Range	Repeatability	Accuracy	Outgoing cable direction	Output signal	Output interface
7134-10-U	.45"	20µin	40µin	horizontal	RS232, TTL level	
7134-10L-U	.45"	20µin	40µin	vertical	RS232, TTL level	
7134-11-U	.45"	20µin	40µin	horizontal	RS232, 232 level	
7134-11L-U	.45"	20µin	40µin	vertical	RS232, 232 level	
7134-12-U	.45"	20µin	40µin	horizontal	RS485	
7134-12L-U	.45"	20µin	40µin	vertical	RS485	
7134-13-U	.45"	20µin	40µin	horizontal	RS232, TTL level	
7134-13L-U	.45"	20µin	40µin	vertical	RS232, TTL level	
7134-14-U	.45"	20µin	40µin	horizontal	RS232, 232 level	
7134-14L-U	.45"	20µin	40µin	vertical	RS232, 232 level	



## Dust/waterproof IP43, resolution 20µin

Code	Range	Repeatability	Accuracy	Outgoing cable direction	Output signal	Output interface
7134-20-U	.45"	60µin	120µin	horizontal	RS232, TTL level	
7134-20L-U	.45"	60µin	120µin	vertical	RS232, TTL level	
7134-21-U	.45"	60µin	120µin	horizontal	RS232, 232 level	
7134-21L-U	.45"	60µin	120µin	vertical	RS232, 232 level	
7134-22-U	.45"	60µin	120µin	horizontal	RS485	
7134-22L-U	.45"	60µin	120µin	vertical	RS485	
7134-23-U	.45"	60µin	120µin	horizontal	RS232, TTL level	
7134-23L-U	.45"	60µin	120µin	vertical	RS232, TTL level	
7134-24-U	.45"	60µin	120µin	horizontal	RS232, 232 level	
7134-24L-U	.45"	60µin	120µin	vertical	RS232, 232 level	

**Dust/waterproof IP66, resolution 10µm**

Code	Range	Repeatability	Accuracy	Outgoing cable direction	Output signal	Output interface
7134-30-U	.45"	20µm	40µm	horizontal	RS232, TTL level	
7134-30L-U	.45"	20µm	40µm	vertical	RS232, TTL level	
7134-31-U	.45"	20µm	40µm	horizontal	RS232, 232 level	
7134-31L-U	.45"	20µm	40µm	vertical	RS232, 232 level	
7134-32-U	.45"	20µm	40µm	horizontal	RS485	
7134-32L-U	.45"	20µm	40µm	vertical	RS485	
7134-33-U	.45"	20µm	40µm	horizontal	RS232, TTL level	
7134-33L-U	.45"	20µm	40µm	vertical	RS232, TTL level	
7134-34-U	.45"	20µm	40µm	horizontal	RS232, 232 level	
7134-34L-U	.45"	20µm	40µm	vertical	RS232, 232 level	

**Dust/waterproof IP66, resolution 20µm**

Code	Range	Repeatability	Accuracy	Outgoing cable direction	Output signal	Output interface
7134-40-U	.45"	60µm	120µm	horizontal	RS232, TTL level	
7134-40L-U	.45"	60µm	120µm	vertical	RS232, TTL level	
7134-41-U	.45"	60µm	120µm	horizontal	RS232, 232 level	
7134-41L-U	.45"	60µm	120µm	vertical	RS232, 232 level	
7134-42-U	.45"	60µm	120µm	horizontal	RS485	
7134-42L-U	.45"	60µm	120µm	vertical	RS485	
7134-43-U	.45"	60µm	120µm	horizontal	RS232, TTL level	
7134-43L-U	.45"	60µm	120µm	vertical	RS232, TTL level	
7134-44-U	.45"	60µm	120µm	horizontal	RS232, 232 level	
7134-44L-U	.45"	60µm	120µm	vertical	RS232, 232 level	